

# Ready-Set-Sew

## Getting Started Guide



Congratulations on the purchase of your new sewing machine. We've compiled a few tips that will help you get the most out of your new purchase and increase your enjoyment of sewing.

*Note: Your machine may vary from these illustrations. Always refer to your instruction manual for exact details on your machine.*

### Bobbin Winding

In order to ensure correct bobbin winding, follow the below diagram for correct threading. Use both hands to thread machine around the guide for correct tension.

**Pro tip:** Because different brands of thread unwind in various manners, sometimes it is helpful to lightly hold/guide the thread as it comes off the spool. This will help create smooth and tightly wound bobbins - which is important for a good stitch.

- 

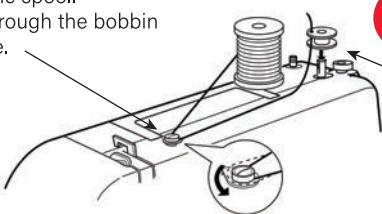
1 Pull the handwheel out.
- 

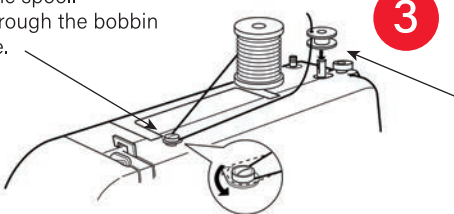
2 Draw thread from the spool. Guide the thread through the bobbin winder thread guide.
- 

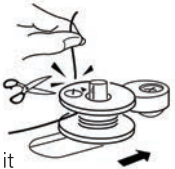
3 Insert the thread through the hole in the bobbin from the inside to the outside. Put the bobbin on the bobbin winder spindle.
- 

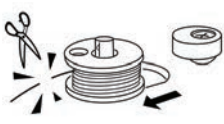
4 Push bobbin winder spindle to the right. With the free end of the thread held in your hand, depress the foot control. Stop the machine when it has made a few turns, and cut the thread close to the hole in the bobbin.
- 

5 Depress the foot control again. When the bobbin is fully wound, stop the machine. Return the bobbin winder spindle to its original position by moving the spindle to the left, and cut the thread.
- 

6 Push the handwheel back to its original position.

### Threading The Machine

Before you begin to thread, make sure the presser foot is in the up position and the needle is at the highest position. Lift the foot by using the presser foot lifter. Turn the handwheel towards you (anti-clockwise) to raise the thread take-up lever to its highest position. This will help ensure that the threading guides are in the proper position to receive the thread.

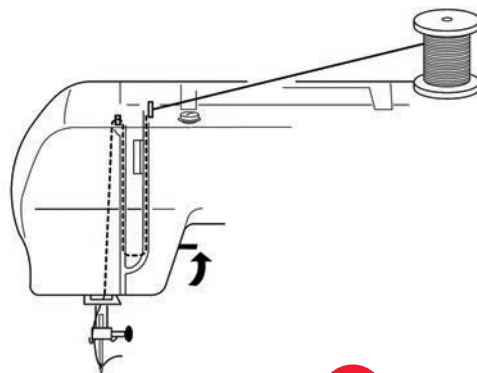

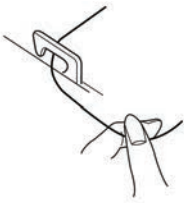
- 

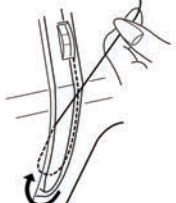
1 Spool off enough thread. Hold upper thread at the reel and thread with other hand. Slip thread under top thread guide.
- 

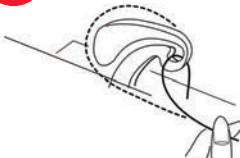
2 Guide thread down right channel and around the bottom of the thread guide plate. Pull firmly to ensure thread slots into tension disks.
- 

3 Firmly, draw thread up left channel and into the thread take-up lever.
- 

4 Guide the thread down through the lower thread guide, then slip it into the needle bar thread guide positioned at the top left of the needle. Lastly, thread the needle eye from the front to the back.

# Getting Started Guide

## Removing or Inserting the Bobbin Case

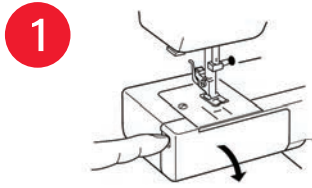

Open the hook cover.

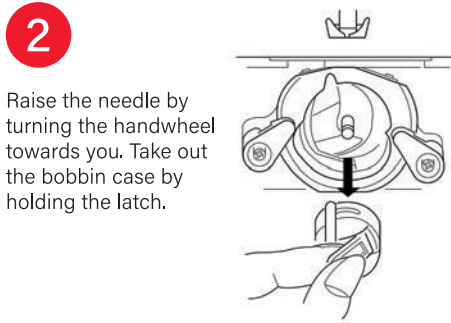

Raise the needle by turning the handwheel towards you. Take out the bobbin case by holding the latch.

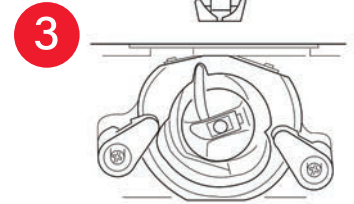

When inserting the bobbin case, place the horn into the recess of the hook race so it is sitting in a 12 o'clock position.

## Bobbin Threading

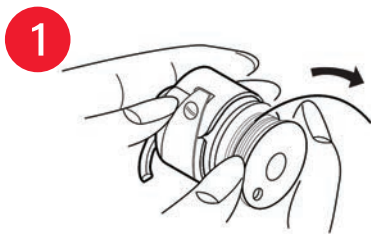

Place the bobbin into the bobbin case. Make sure the thread unwinds in the direction of arrow. Bobbin turns clockwise as you look at bobbin in bobbin case.

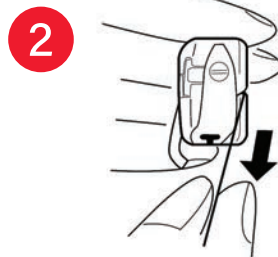

Pull the thread into the bobbin case slot.

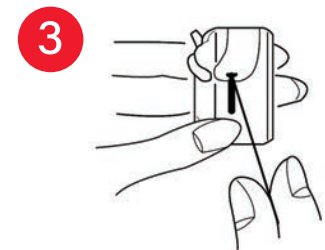

Draw the thread under the tension spring and into the delivery eye. Leave about 10 cm (4") of free thread.

## Picking up the Bobbin Thread

Before you begin to sew, the bobbin thread needs to be pulled up onto the sewing bed. Gently hold the needle thread in your left hand and slowly turn the handwheel towards you with your right hand until you see the bobbin thread looped around the needle thread. Using your fingers, grab the bobbin thread and pull up a 15 cm/6" length.

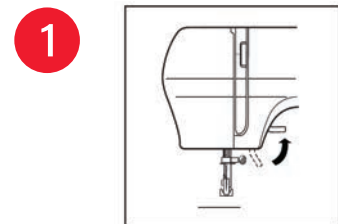

Raise presser foot.

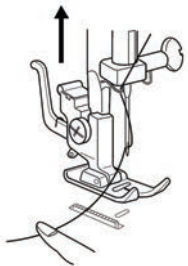

2 Hold the needle thread lightly with your left hand.

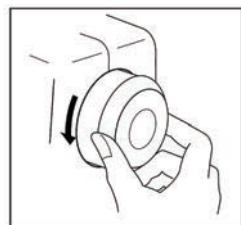

3 Turn the handwheel slowly toward you with your right hand until the needle goes down and continue turning the handwheel until the take-up lever is at its highest position.

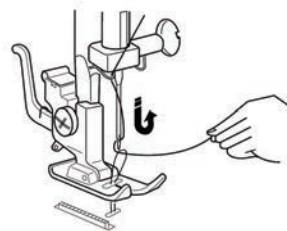

4 Lightly draw up the needle thread forming a loop of the bobbin thread.

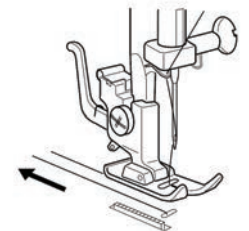

5 Pull 15 cm (6") of both threads back and under the presser foot.

## Sewing Over Thick Fabrics

Even though sewing machines can handle various types of fabrics, it's important to keep in mind that when sewing on thick fabrics like denim, that seams can become very thick. It is important to keep the presser foot level when sewing over these seams or uneven surfaces.

**Pro tip:** A quick fix is to fold a scrap of fabric 2 - 3 times and put it behind the needle and underneath the presser foot when you approach the seam or hump in your fabric. This will help to level your foot and keep your fabric feeding correctly.

## The Thread Loops on the Underside or Topside of the Fabric

**Pro tip:** Problems with your stitching are the opposite of what you might think. If the thread is looping on the underside, re-check the upper threading on your machine. The thread may not be correctly seated in the tension disks or has come out of the take-up lever.

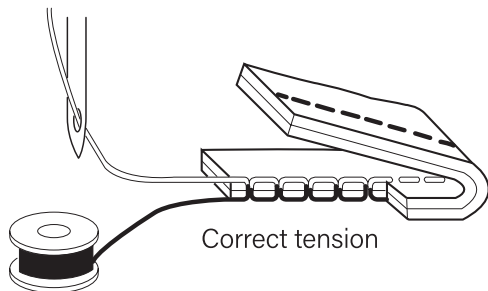

Conversely, if the thread is looping on top, make sure the bobbin thread is coming off the bobbin anti-clockwise and that the thread is securely threaded in the bobbin tension spring.

Refer to your instruction manual for more information.

## Machine or Needle is Jammed

Using scissors, carefully cut away thread above and below fabric. Gently pull the fabric away from the presser foot area, while making slight turns on the handwheel to raise the needle.

Inspect the needle to make sure it isn't bent. If so, replace it. Before re-threading the needle, turn the handwheel toward you making sure that there isn't any more lint or fabric in the feed dogs or in the bobbin area.

**Pro tip:** When you are done stitching, make sure that the needle is in the highest position before you remove the fabric from the machine. This will ensure that the upper thread has made a full rotation around the bobbin case, preventing thread jams in the bobbin area.

## Machine Won't Turn On

Check to make sure that the cord is plugged into the wall.

Check to make sure that the power cord is plugged into the sewing machine.

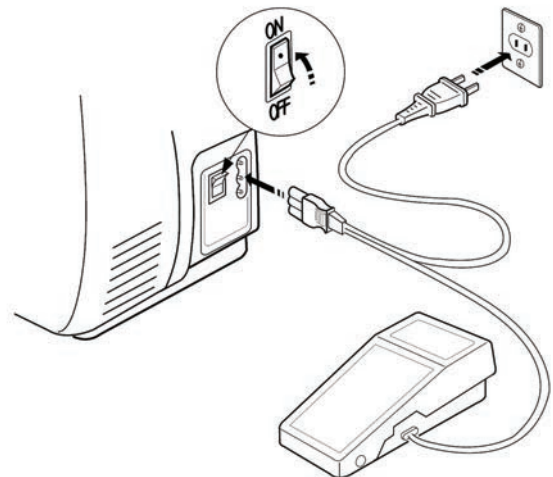

# Troubleshooting Tips

## Top Tips

### Always turn the handwheel towards you

Anti-clockwise. Turning away from you can cause threads to tangle and break when starting to sew.

### No Power

Check main power supply is turned on, power cord and foot control are connected.

### Machine Not Feeding Fabric

Check that the Feed Dogs are raised and clean. These are the teeth under the presser foot that feed the fabric when stitching.

Check that the stitch length is set for correct weight of fabric.

**Pro tip:** Increasing the stitch length enhances the feed dog function, enabling it to pull through more fabric.

### Machine Not Running Smoothly

Check the bobbin area. Does it need cleaning? Is there a lint build-up?  
Thread may be caught in the bobbin area.

### Skipped / Bad Stitching

Rethread the machine with the presser foot raised and the take-up lever in the highest position. Follow the threading guides and check that the thread is in the take-up lever.

Check that the needle is inserted correctly, flat side to the back.

Check that the needle is not bent or blunt and is the correct type of needle.

Check that the tension setting is correct (average setting for a straight stitch is approx. 4).

Check that the tension disk area is clean.

Check that the bobbin is placed in the bobbin holder correctly. The bobbin should turn anti-clockwise when pulling the thread.

Elna sewing machines use Organ brand of needle, available from Elna stockist. Using other needles may cause stitching issues.

Register your machine today



# Happy Stitching!

